

Service
Service
Service

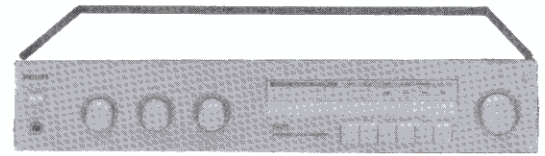

Service Manual

Voedingsspanning	: 110-127-220-240 V AC
Opgenomen vermogen	: 185 W (IEC)
Uitgangsvermogen	
FTC	: 2x20 W D ≤ 0,09%
IEC	: 2x25 W D ≤ 0,7 %
DIN	: 2x26 W D ≤ 0,7 %
Uitgangen	
2x2 luidsprekers	: 8 Ω
Hoofdtelefoon	: 8-1000 Ω
Recorder	: 150 mV/2,5 kΩ
Ingangen	
Phono MD	: 2,5 mV/47 kΩ
Recorder	: 150 mV/47 kΩ
Compact disc	: 150 mV/47 kΩ
Tuner	: 150 mV/47 kΩ
Harmonische vervorming	: 0,008%-20 W-1 kHz
Intermodulatie vervorming	: 0,04 %-20 W
Afmetingen (bxhxd)	: 420x73/79x300 mm

Veiligheidsbepalingen vereisen, dat het apparaat bij reparatie in zijn oorspronkelijke toestand wordt teruggebracht en dat onderdelen, identiek aan de gespecificeerde, worden toegepast.

Voor meer uitgebreide technische specificaties gelieve de commerciële documentatie te raadplegen.



F4130

OS/05/05S



al

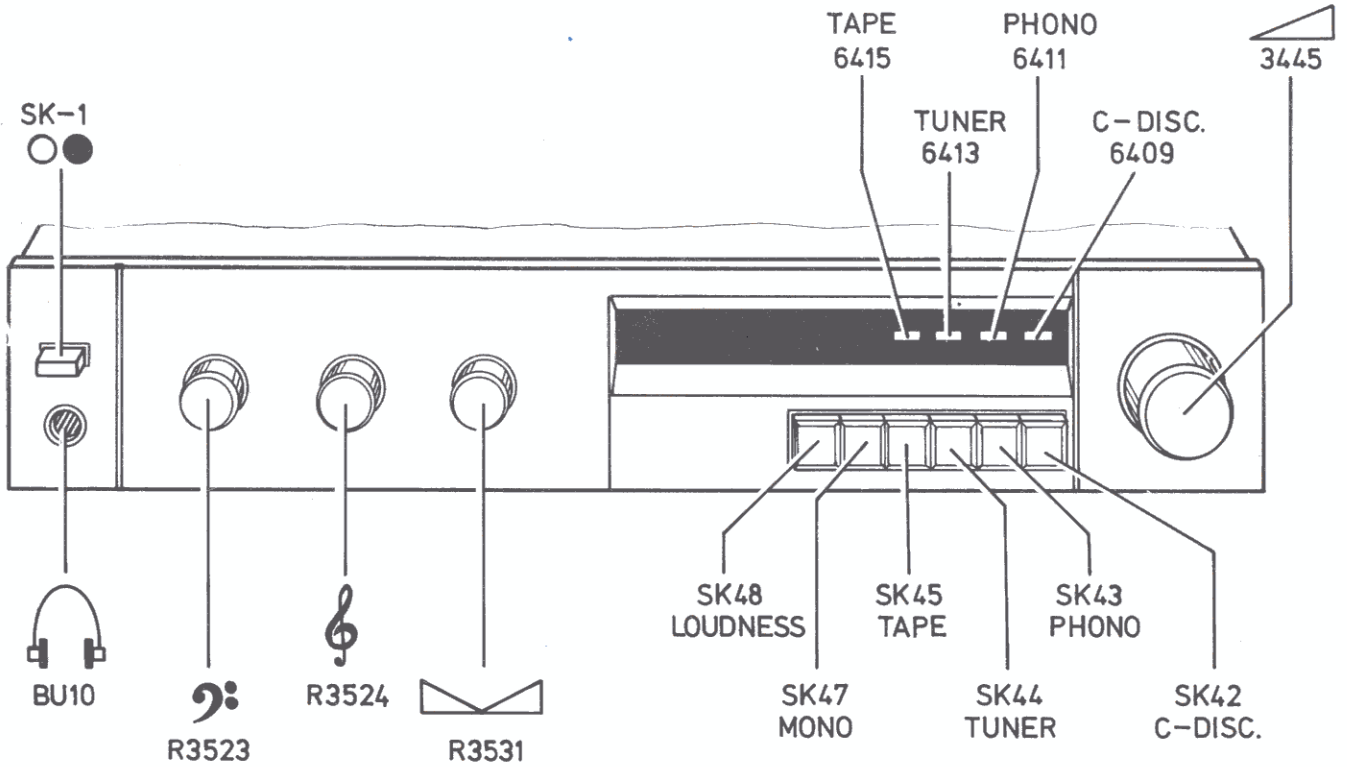

31 891 A12

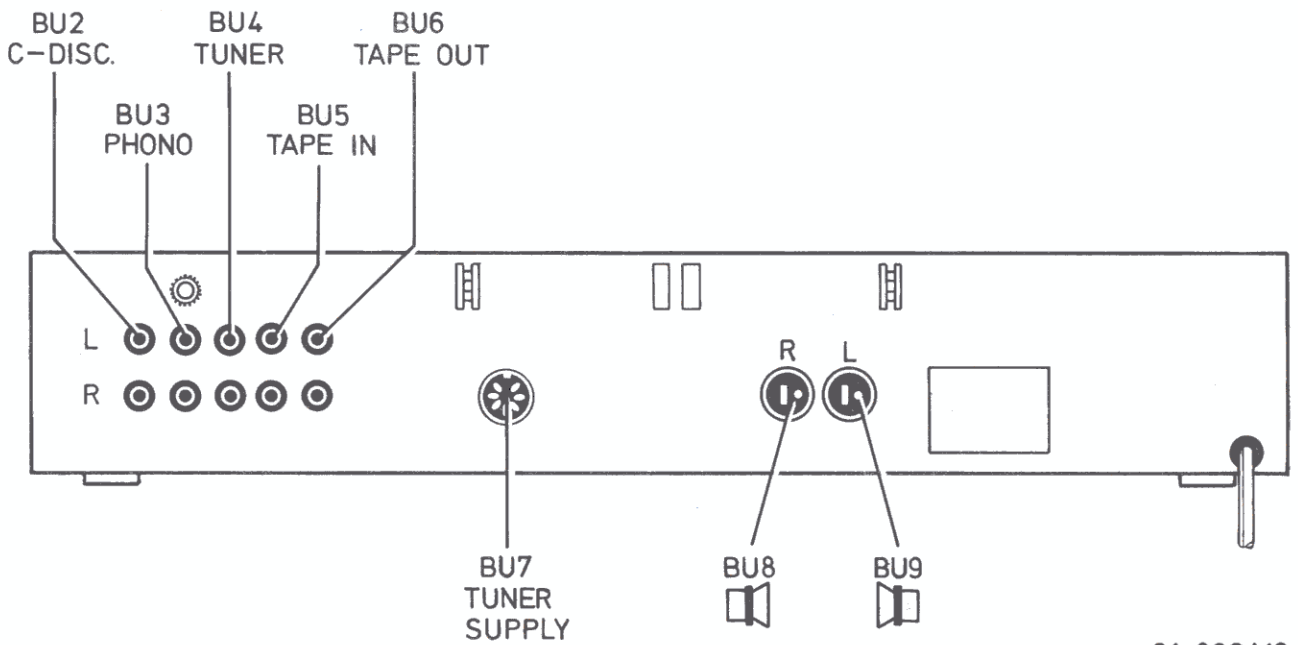

31 892A12

e de

al de Serviço

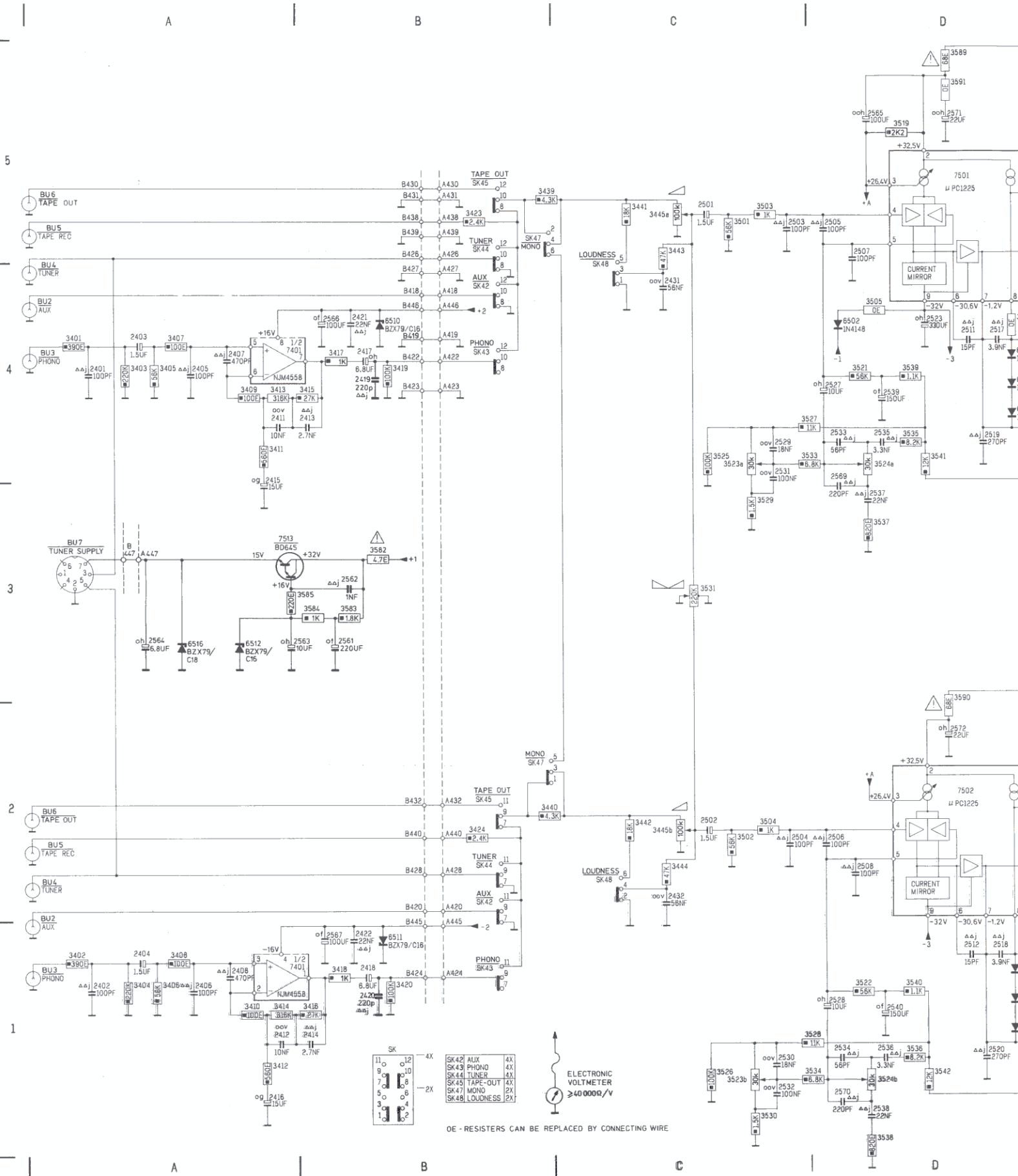

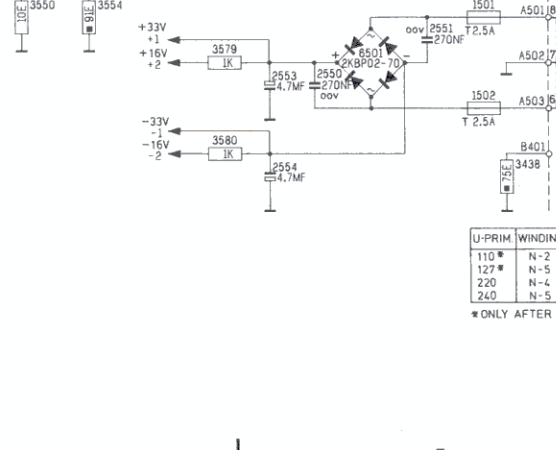
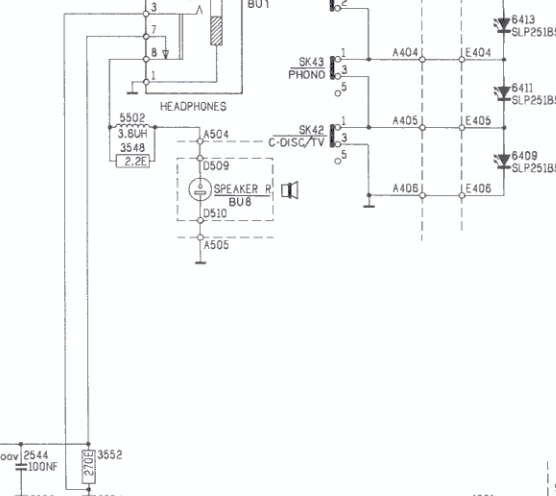
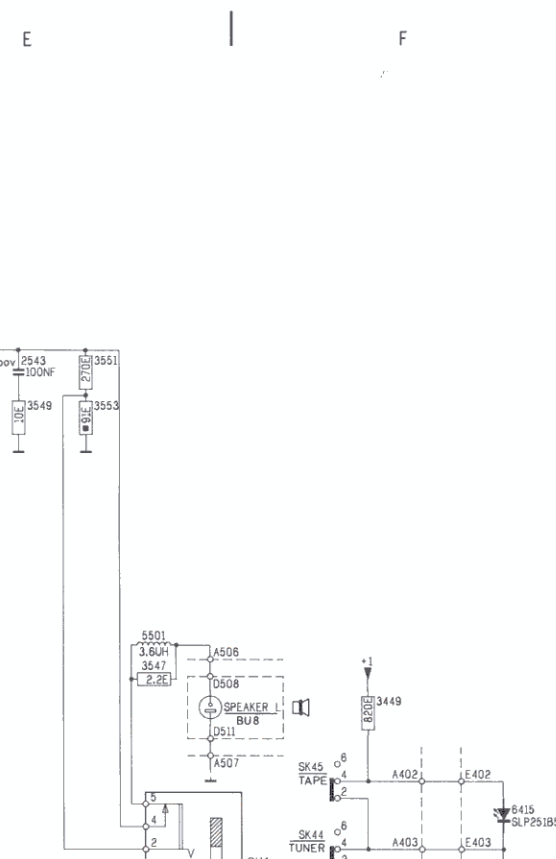
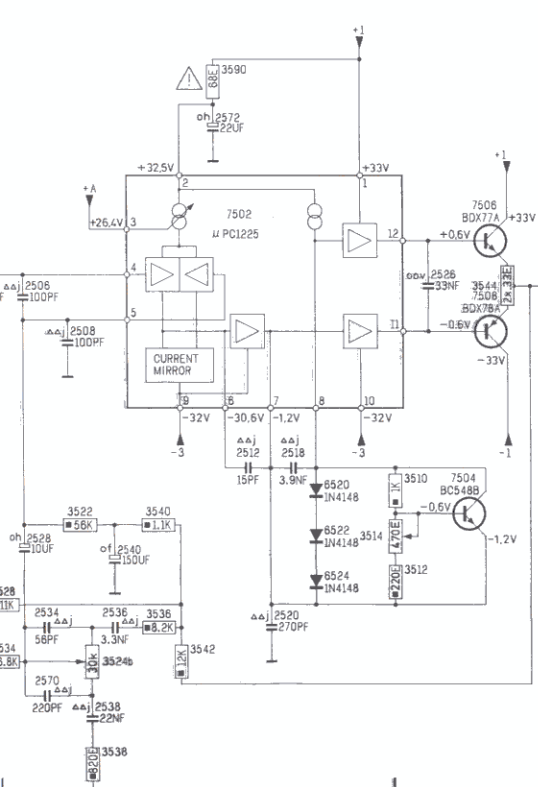
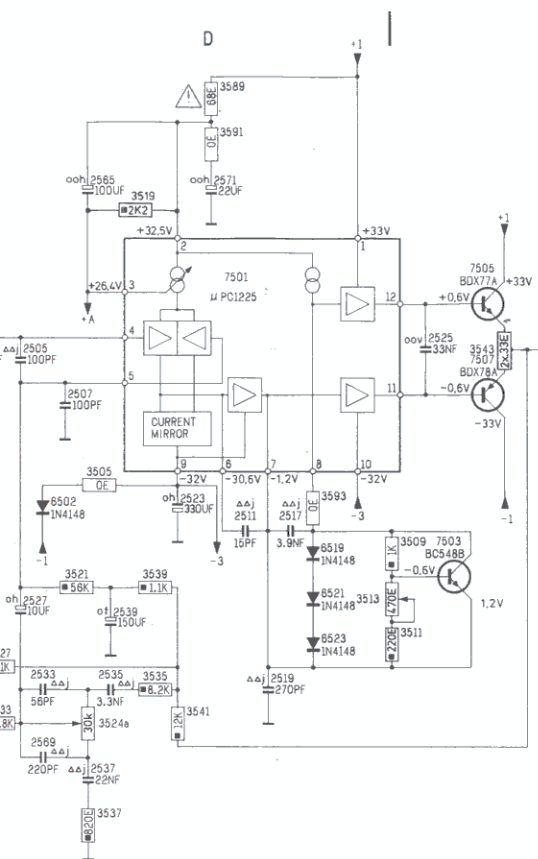

U-PRIM WINDING	INTERCONNECT
110 #	N-2 1-3 2-4
127 #	N-5 1-3 2-4
220	N-4 2-3
240	N-5 2-3

* ONLY AFTER INTERRUPTION OF 2-3

31 425 E15

ITEM	CD	ITEM	CD
1501	F02	3439	B05
1502	F01	3440	C02
2401	A04	3441	C05
2402	A01	3442	C02
2403	A04	3443	C05
2404	A01	3444	C02
2405	A04	3445	C05
2406	A01	3449	F04
2407	A04	3501	C05
2408	A01	3502	C02
2411	A04	3503	C05
2412	A01	3504	C02
2413	B04	3505	D04
2414	B01	3509	E04
2415	A04	3510	E01
2416	A01	3511	E04
2417	B04	3512	E01
2418	B01	3513	E04
2419	B04	3514	E01
2420	B01	3519	D05
2421	B04	3521	D04
2422	B01	3522	D01
2431	C04	3523	C01
2432	C02	3524	C04
2501	C05	3525	C04
2502	C02	3526	C01
2503	C05	3527	C04
2504	C02	3528	D01
2505	D05	3529	C03
2506	D02	3529	C03
2507	D05	3530	C01
2508	D02	3531	C03
2511	D04	3531	C03
2512	D01	3533	C04
2517	D04	3534	D01
2518	D01	3535	D04
2519	D04	3536	D01
2520	D01	3537	D03
2523	D04	3538	D01
2525	E05	3539	D04
2526	E02	3540	D01
2527	D04	3541	D04
2528	D01	3542	D01
2529	C04	3543	E05
2530	C01	3544	E02
2531	C04	3547	E04
2532	C01	3548	E03
2533	D04	3549	E05
2534	D01	3550	E02
2535	D04	3551	E05
2536	D01	3552	E02
2537	D03	3553	E05
2538	D01	3554	E02
2539	D04	3579	E01
2540	D01	3580	E01
2543	E05	3582	B03
2544	E02	3583	B03
2550	F02	3584	B03
2551	F02	3585	B03
2553	F02	3589	D05
2554	F01	3590	D02
2561	B03	3591	D05
2562	B03	3593	D04
2563	B03	5501	E04
2564	A03	5502	E03
2565	D05	6409	F03
2566	B04	6411	F03
2567	B01	6413	F03
2569	D04	6415	F03
2570	D01	6501	F02
2571	D05	6502	D04
2572	D02	6510	B04
3401	A04	6511	B01
3402	A01	6512	A03
3403	A04	6516	A03
3404	A01	6519	D04
3405	A04	6520	D01
3406	A04	6521	D04
3407	A04	6522	D01
3408	A01	6523	D04
3409	A04	6524	D01
3410	A01	7401	B04
3411	A04	7501	D05
3412	A01	7502	D02
3413	A04	7503	E04
3414	A01	7504	E01
3415	B04	7505	E05
3416	B01	7506	E02
3417	B04	7507	E05
3418	B01	7508	E02
3419	B04	7513	A03
3420	B01		
3423	B05		
3424	B02		
3438	F01		

- 400 4822 413 41153
- 401 4822 413 41152
- 402 5322 505 10422
- 403 4822 426 50591
- 404 4822 410 22934
- 406 4822 276 11162
- 407 4822 410 30283
- 408 4822 413 70174
- 409 4822 410 30282
- 410 4822 450 60337
- 411 4822 267 30513
- 412 4822 256 90538
- 413 4822 267 30377
- 414 4822 276 11095
- 416 4822 462 40409
- 417 4822 267 50362
- 419 4822 267 50429
- 420 4822 267 40503

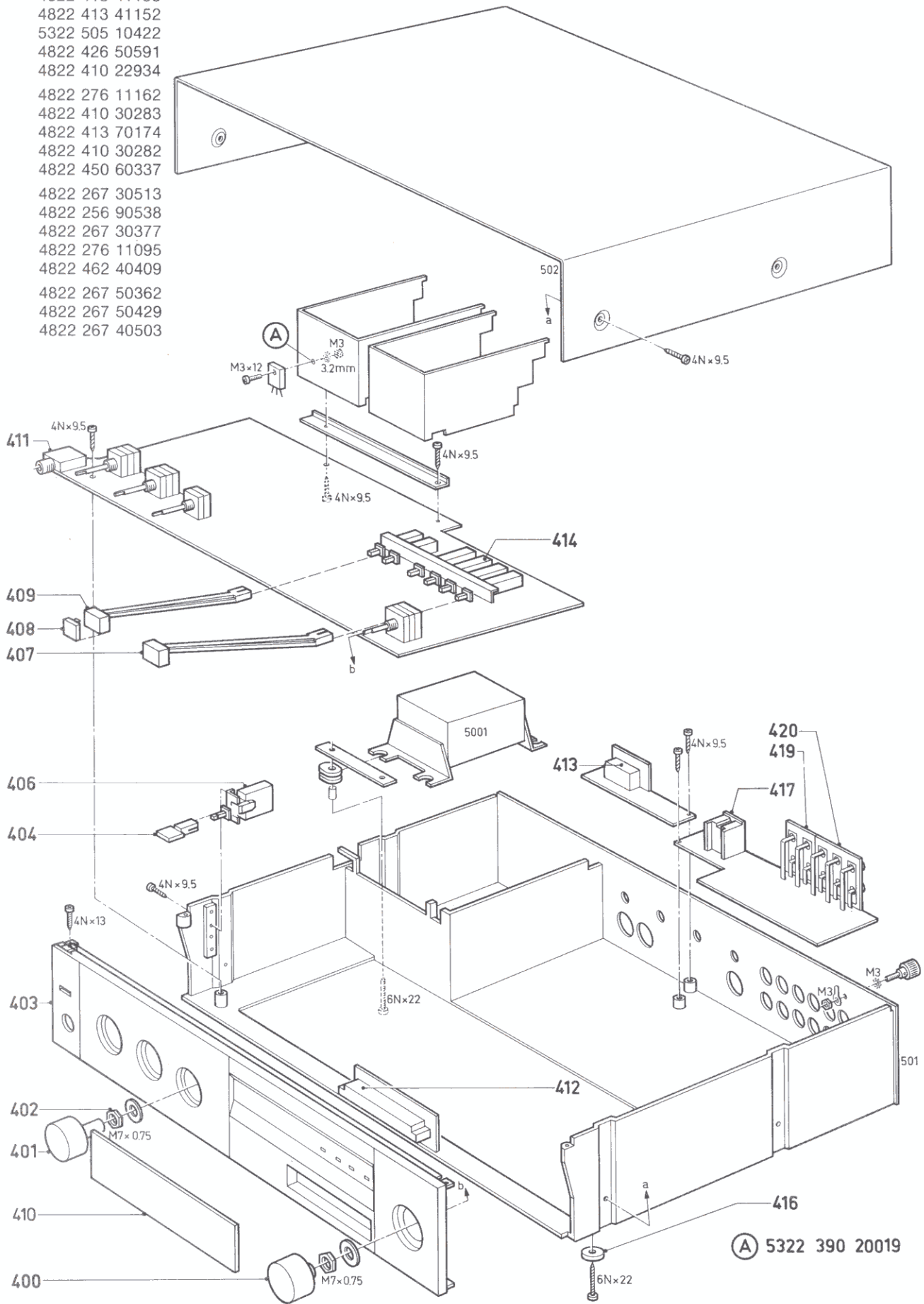

(A) 5322 390 20019

Algemeen

- Belastingsv...
- uitgangen k...
- Volumereg...
- Apparaat in...
- uit.
- Toon en ba...
- Alle meting...
- 1 kHz en in...
- Een belas...
- (5%-3 W) t...

Ruststroom ins...

Linkerkanaal: R3543.
Rechterkanaal: R3544.

Opwarmtijd va...
*45 mV komt o...

Voeding

SK	
SK45 tape	

(A)* Versterk

Uitgangsverm...

SK	
Tape SK45	

(B) Signalen

Offsetspannin...
Zonder ingan...
spanning op

Algemeen

- Belastingweerstand van 8Ω -80 W 1% over de uitgangen L en R systeem A.
- Volumeregelaar in stand „max.”.
- Apparaat in stand „stereo” met contourschakelaar uit.
- Toon en balansregeling in middenstand.
- Alle metingen gebeuren met een testfrequentie van 1 kHz en in systeem A tenzij anders vermeld.
- Een belastingsweerstand aanbrengen van 150Ω (5%-3 W) tussen punt 2 en 7 van de DIN socket.

Ruststroom instellen



Linkerkanaal: R3513 afregelen voor 45 mV^* ($\pm 5\%$) over R3543.

Rechterkanaal: R3514 afregelen voor 45 mV^* ($\pm 5\%$) over R3544.

Opwarmtijd van het apparaat ± 15 minuten.



* 45 mV komt overeen met 68 mA ruststroom.

Voeding

SK		+Vcc	-Vcc	DC point 7 and 2 DIN plug
SK45 tape	min.	$33.5 \text{ V} \pm 1.2 \text{ V}$ ripple $\leq 100 \text{ mVeff}$	$-33.5 \text{ V} \pm 1.2 \text{ V}$ ripple $\leq 100 \text{ mVeff}$	$14.5 \text{ V} + 1.2 \text{ V}$ ripple $\leq 6 \text{ mVeff}$
	max 	$+26.5 \text{ V} \pm 1.2 \text{ V}$ $\leq 100 \text{ mVeff}$	$-26.5 \text{ V} \pm 1.2 \text{ V}$ $\leq 100 \text{ mVeff}$	





* Versterker uitsturen voor $2 \times 26 \text{ W}$ ($14,42 \text{ V}$)















Uitgangsvermogen en vervorming

SK	 \rightarrow 	FTC $2 \times 20 \text{ W}$ (12.65 V)	IEC $2 \times 25 \text{ W}$ (14.14 V)	DIN45500 $2 \times 26 \text{ W}$ (14.42 V)
Tape SK45	40 Hz	0.09%		
	63 Hz		0.7%	
	100 Hz	0.01%	0.3%	0.7%
	12.5 kHz		0.7%	
	20 kHz	0.09%		

 Signalen insturen via $1 \text{ k}\Omega$

Offsetspanning op de luidsprekeruitgang.
Zonder ingangssignaal is de max. toegelaten DC spanning op de speakeruitgang $\leq 200 \text{ mV}$.

-Miscellaneous-			-S- 		
1501	Fuse 2.5 AT	4822 253 30026	5501	Coil 3.6 μ H	4822 157 50718
1502			5502		
5001	Mainstrafo	4822 146 30436			
-C- II-			-D- 		
2403			6501	Diode bridge	4822 130 32037
2404	ILL elco 1.5 μ F 50 V	4822 124 21125	6502		
2501			6519		
2502			6520		
2553 }	Elco 4700 μ F 40 V	4822 124 21388	6521	1N4148	4822 130 30621
2554 }			6522		
			6523		
			6524		
			6510		
			6511	BZX79/C18	4822 130 31024
			6516		
-R- 			-IC- 		
3413	Met. film res 316k	5322 116 55268	7401	NJM4558DD	4822 209 81054
3414			7501	UDC1225H	4822 209 81561
3437	Potmeter 2x100k	4822 105 10503	7502		
3445	Potmeter	4822 101 30498			
3513 }	Trimpotm. 1k	4822 100 10037			
3514 }					
3523 }	Potmeter	4822 101 30499			
3524 }					
3531	Potmeter	4822 101 30501			
3543 }	W.W. res. 2x0.33E	4822 113 41095			
3544 }					
3547 }	Pow. met. res. 2E2	4822 116 51499			
3548 }					
3549 }	Met. film res. 10E	5322 116 54214			
3550 }					
3551 }	Power met. res. 270E	4822 116 51103			
3552 }					
3579 }	Met. film res. 1k	5322 116 54207			
3580 }					
3582	Safety res. 4E7	4822 111 30499			
3589 }	Safety res. 68E	4822 111 30007			
3590 }					
			-TS- 		
			7503 }	BC548B	4822 130 40937
			7504 }		
			7505 }	BDX77A	4822 130 42101
			7506 }		
			7507 }	BDX78A	4822 130 42102
			7508 }		
			7513	BD645	4822 130 41123

	Carbon film 0.2 W 70°C 5%		Ceramic plate Tuning ≤ 120 pF NP.0 2% Others -20/+80%	*a = 2,5 V b = 4 V c = 6,3 V d = 10 V e = 16 V f = 25 V g = 40 V h = 63 V j = 100 V l = 125 V m = 150 V n = 160 V q = 200 V r = 250 V s = 300 V t = 350 V u = 400 V v = 500 V w = 630 V x = 1000 V A = 1,6 V B = 6 V C = 12 V D = 15 V E = 20 V F = 35 V G = 50 V H = 75 V I = 80 V
	Carbon film 0.33 W 70°C 5%		Polyester flat foil 10%	
	Metal film 0.33 W 70°C 5%		Metalized polyester flat film 10%	
	Carbon film 0.5 W 70°C 5%		Polyester flat foil small size (Mylar) 10%	
	Carbon film 0.67 W 70°C 5%		Polysterene film/foil 1%	
	Carbon film 1.15 W 70°C 5%		Tubular ceramic	
© Chip component			Miniature single	
			Subminiature tantalum $\pm 20\%$	

27 037A/C

ITEM PCB

1501	B04	3438	H02
1502	B04	3439	G04
2401	H02	3440	G04
2402	H02	3441	F04
2403	H02	3442	G04
2404	H02	3443	F04
2405	H02	3444	G04
2406	H02	3445	H06
2406	H02	3449	H05
2407	H02	3501	E06
2408	H02	3502	E06
2411	H02	3503	D05
2412	G02	3504	C05
2413	H02	3505	D05
2414	G02	3509	D04
2415	H02	3510	D04
2416	G02	3511	D04
2417	H02	3512	G02
2418	H02	3513	D04
2419	H02	3514	D04
2420	H02	3521	D05
2421	H02	3522	C05
2422	G02	3523	B06
2431	F04	3524	C06
2432	F04	3525	B05
2501	D06	3526	B06
2502	D06	3527	C05
2503	D05	3528	B06
2504	C05	3529	C06
2505	D05	3530	C06
2506	C05	3531	D06
2507	D05	3533	C06
2508	C05	3534	D06
2511	D05	3535	C05
2512	C05	3536	B06
2517	D04	3537	D05
2518	D04	3538	D06
2519	D04	3539	C05
2520	D04	3540	B05
2523	C05	3541	C05
2525	E04	3542	B05
2526	E04	3543	E03
2527	D05	3544	E04
2528	C05	3547	C04
2529	C05	3548	C04
2530	D06	3549	C04
2531	C06	3550	C04
2532	C06	3551	B05
2533	C05	3552	B05
2534	C06	3553	B05
2535	C06	3554	B06
2536	C06	3579	D03
2537	D05	3580	D04
2538	D06	3582	B04
2539	D05	3583	B05
2540	B05	3584	C04
2543	C04	3585	C04
2544	C04	3589	D05
2550	B04	3590	C05
2551	B04	3591	C05
2553	C04	3593	D05
2554	D04	5501	D04
2561	B05	5502	C04
2562	C04	6409	G07
2563	C04	6411	G07
2564	C04	6413	G07
2565	D05	6415	G07
2566	G02	6501	B04
2567	G02	6502	D04
2569	D05	6510	G02
2570	D06	6511	G02
2571	D05	6512	C04
2572	C05	6516	C04
3401	H02	6519	D04
3402	H02	6520	D04
3403	H02	6521	D04
3404	H02	6522	D04
3405	H02	6523	D04
3406	G02	6524	D04
3407	H02	7401	H02
3408	H02	7501	D05
3409	H02	7502	C05
3410	H02	7503	D03
3411	H02	7504	D03
3412	G02	7505	F03
3413	H02	7506	E03
3414	G02	7507	E03
3415	H02	7508	D03
3416	G02	7513	B04
3417	H02		
3418	H02		
3419	H02		
3420	G02		
3423	G04		
3424	G04		

1

2

3

4

5

6

7

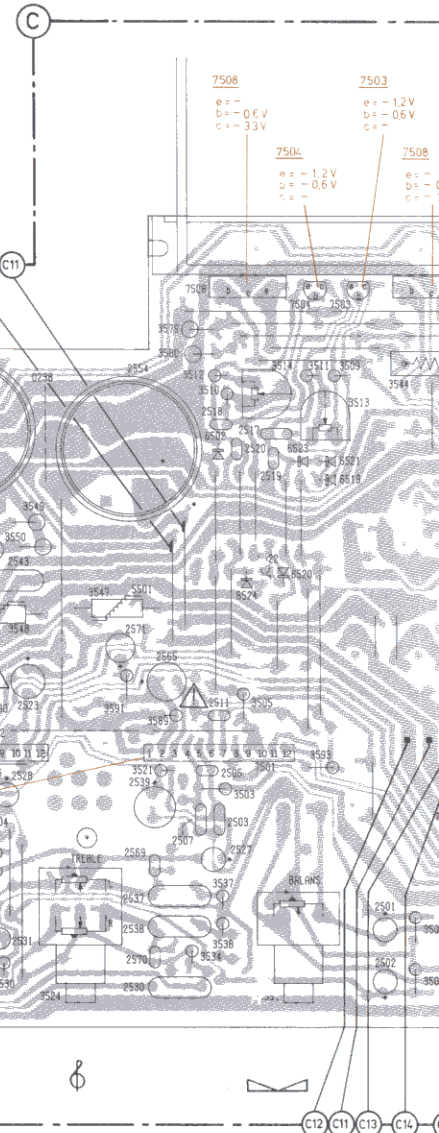
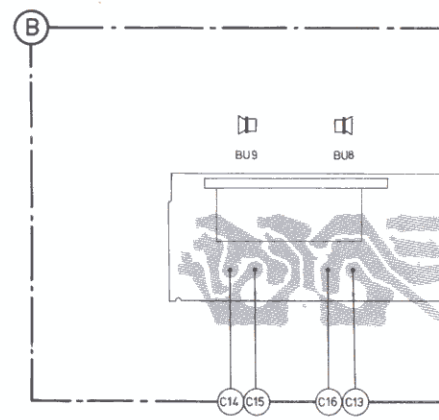
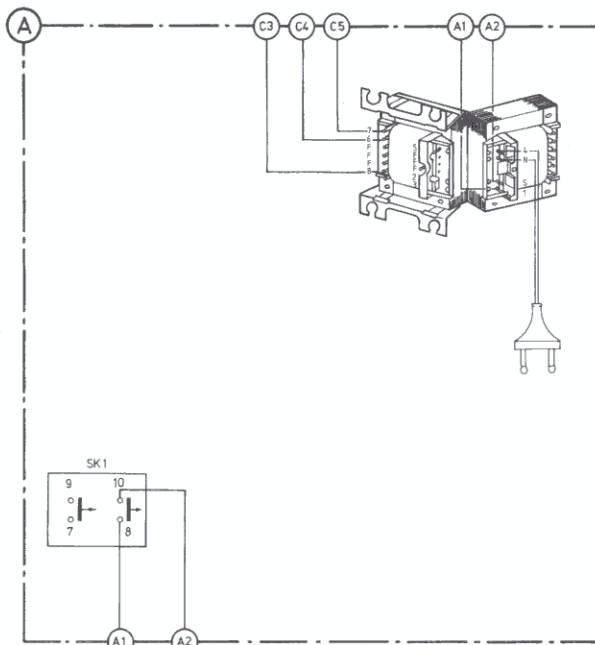

7513
e = +15V
b = +16V
c = +33V

7502
1 = +33V
2 = +32.5V
3 = +26.4V
4 = -
5 = -
6 = -32.6V
7 = -1.2V
8 = -
9 = -32V
10 = -32V
11 = -0.6V
12 = +0.6V

7501
1 = +33V
2 = +32.5V
3 = +26.4V
4 = -
5 = -
6 = -30.6V
7 = -1.2V
8 = -
9 = -32V
10 = -32V
11 = -0.6V
12 = +0.6V

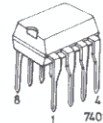
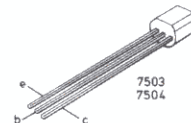
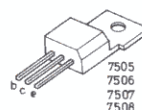
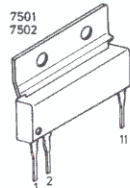
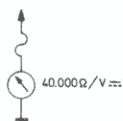

A

B

C

D

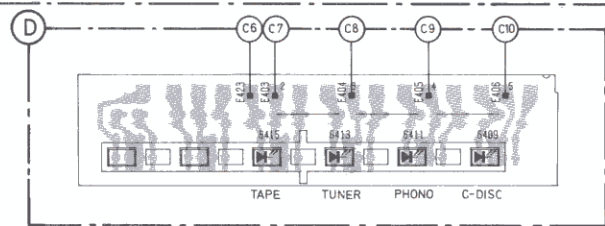
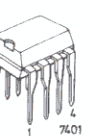
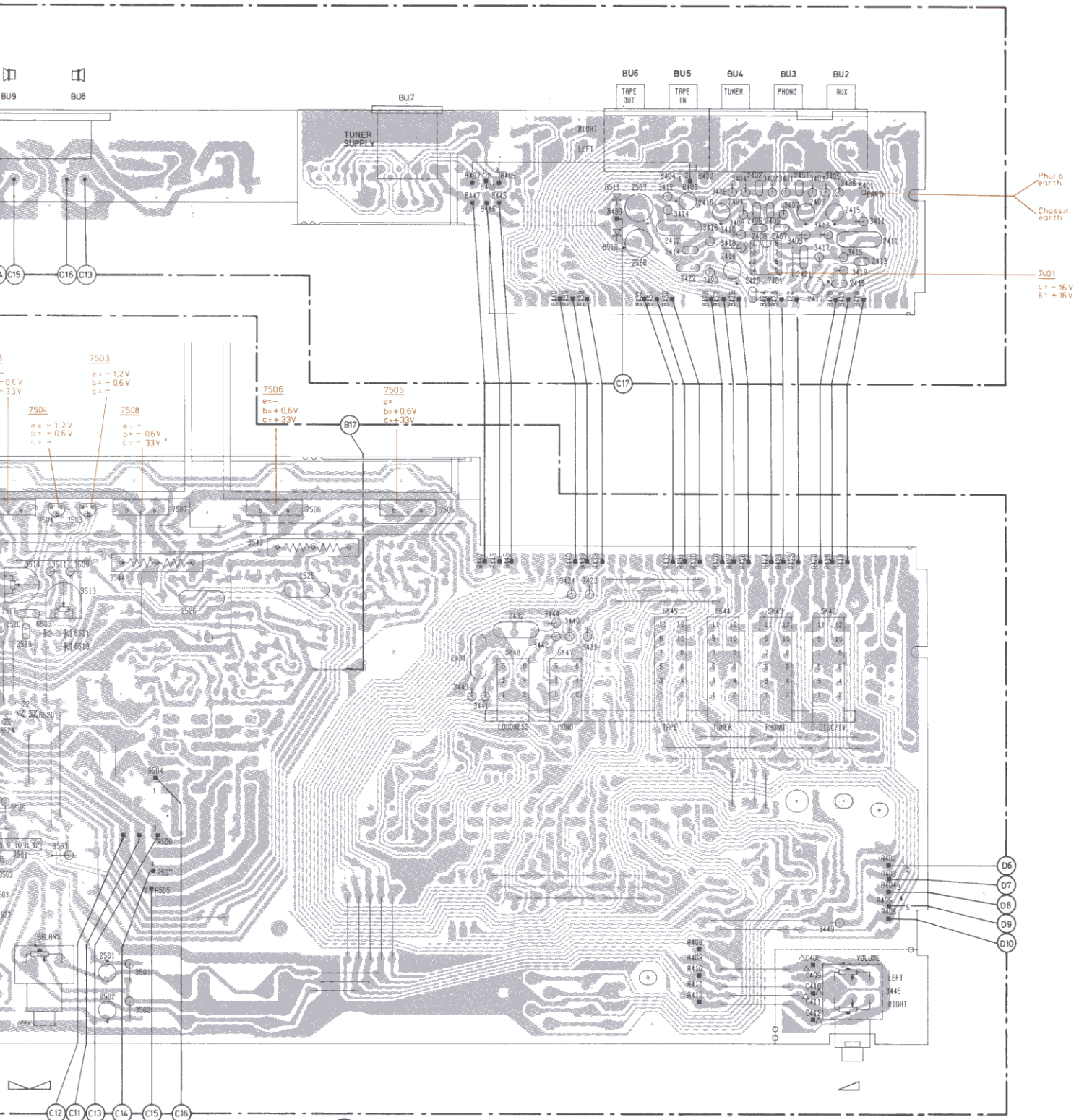

D | E | F | G | H | I